

GIOIRIO[®]
style your interior



ALULUXE

Unveiling Metal's True Beauty



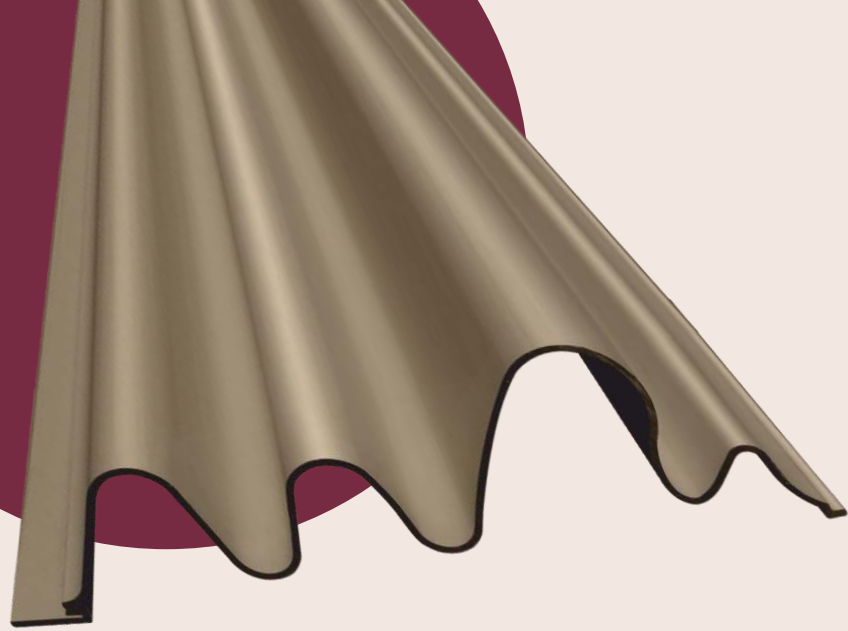

GLOIRIO[®]
style your interior

ALULUXE
Unveiling Metal's True Beauty

Gloirio Aluluxe – an innovation by Gloirio, a premium range of pure Aluminium panels featuring an exquisite parametric design with Seamless Integration that ensures a smooth, continuous appearance.

Aluluxe offers unparalleled aesthetic flexibility, extruded from 6063-T5 grade Aluminium metal, with Electro Plated and Anodized finishes. Ideal for creating facades, ceilings, interior and exterior wall cladding, feature walls, and much more.

Aluluxe also offers precise solutions for 90° inner corners, 90° outer corners, and end solutions. Aluluxe combines elegance with exceptional durability, making it the perfect choice for architects and interior designers seeking innovative, durable, lightweight, and visually stunning products.

Seek timeless sophistication and reliable transformation with Aluluxe by Gloirio.



Durability
& strength



Scratch
Resistant



Easy to
Clean



Light
Weight



Fire
Resistant



Water
Resistance



Borer
Proof



Termite
Proof



Scan for the
Certificate

A PERFECT FIT FOR



INSTALLATION GUIDE

1 Circular saw to be used to cut required length.

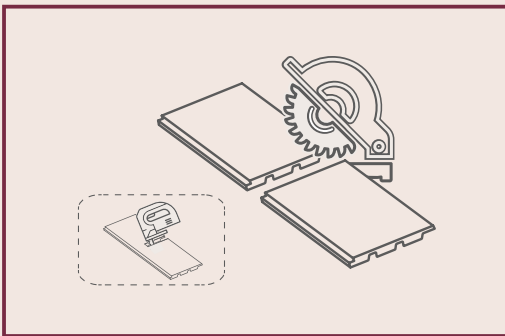

2 Apply a quality adhesive on the back of the Aluminium panels. Apply a small amount of hot melt (glue-gun) on the back of the panels.

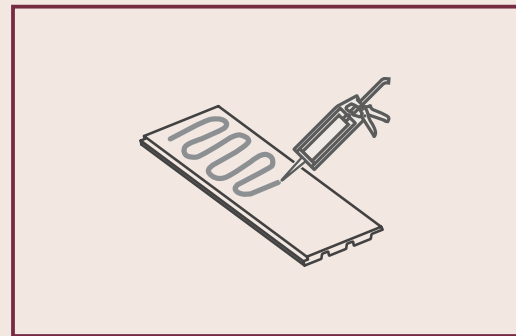

3 Aluminium panels can be installed in both horizontal or vertical direction. Screwing on the tongue/ interlocking space for better fixing.

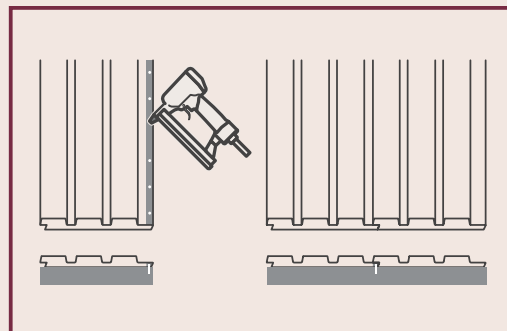

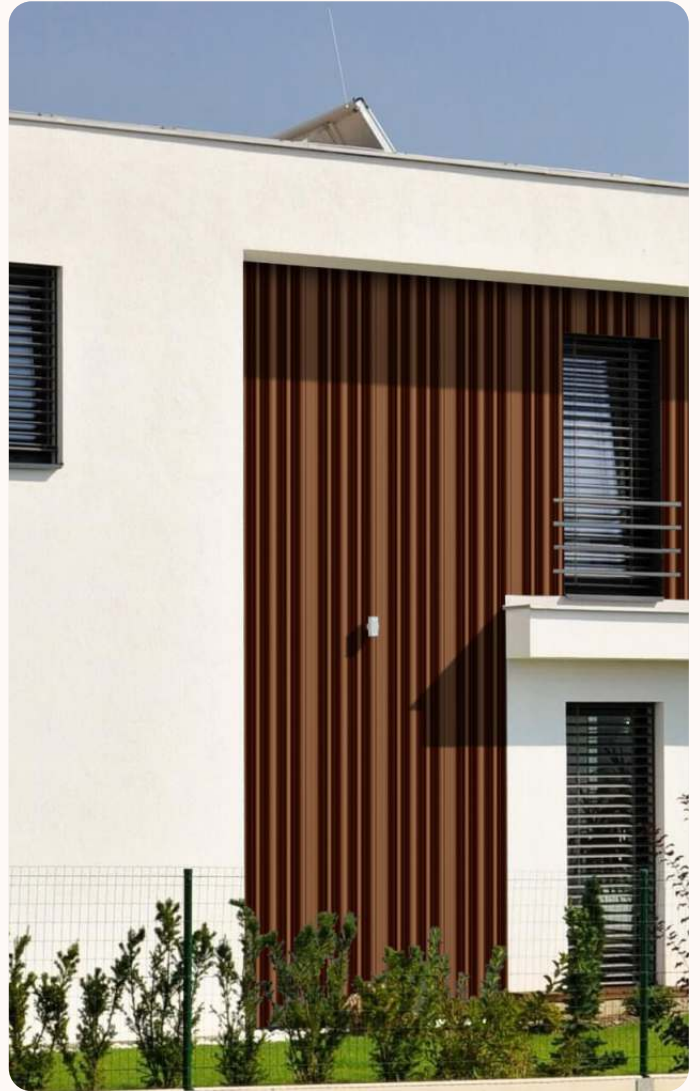

GL 11 2900mm x 121mm x 25mm

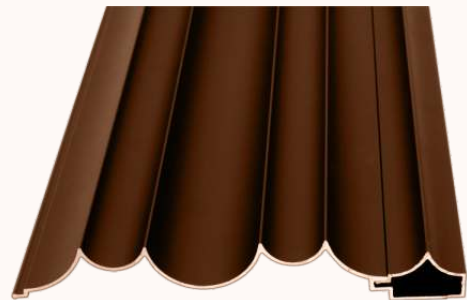

End Profile

Material	Length	Coverage	Weight	Thickness	Tolerance
AL 6063-T5	2900mm	3.15 Sq.ft	1.45 Kg.	1.1mm	±0.20mm

Panel Profile

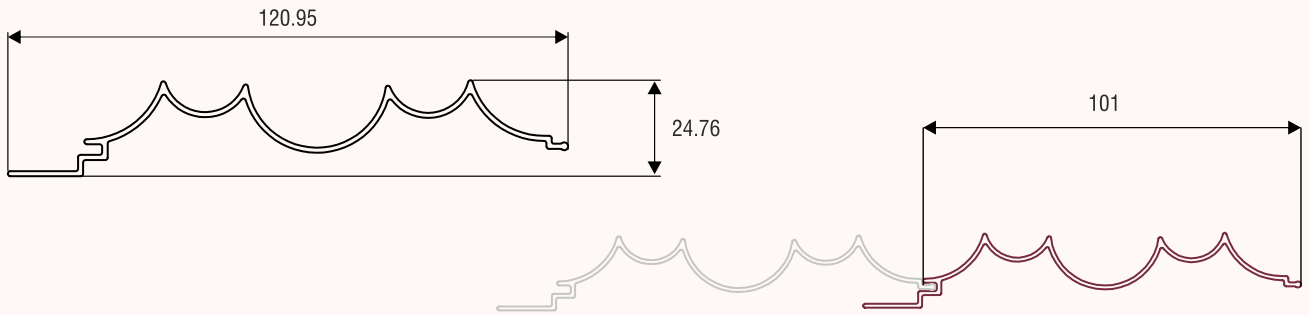

Adjoining Panel Placement

End Profile

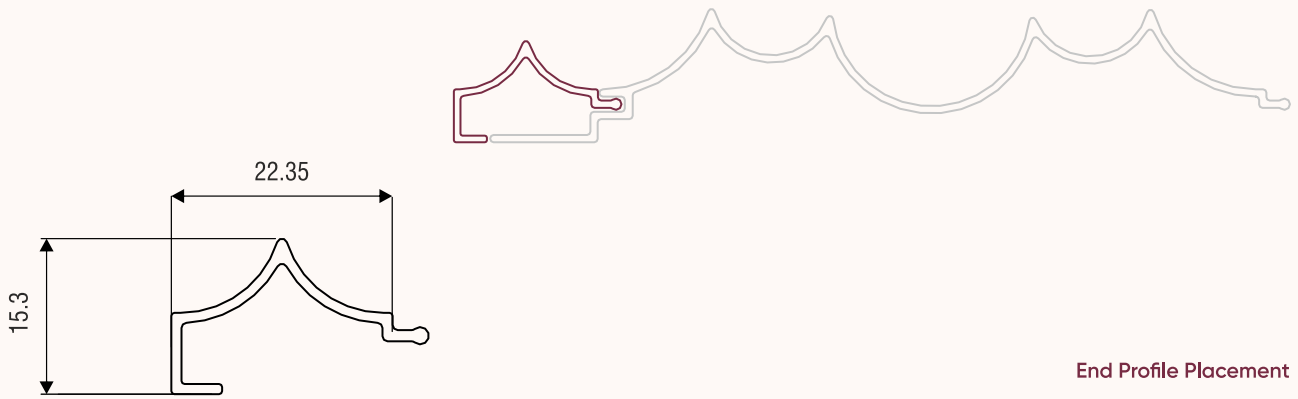

End Profile Placement





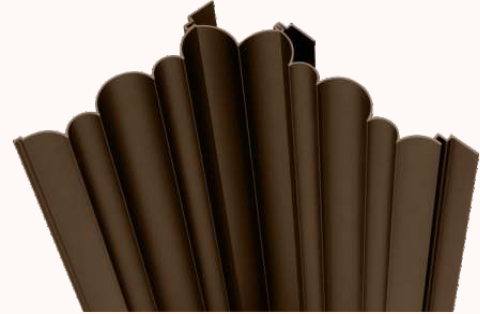
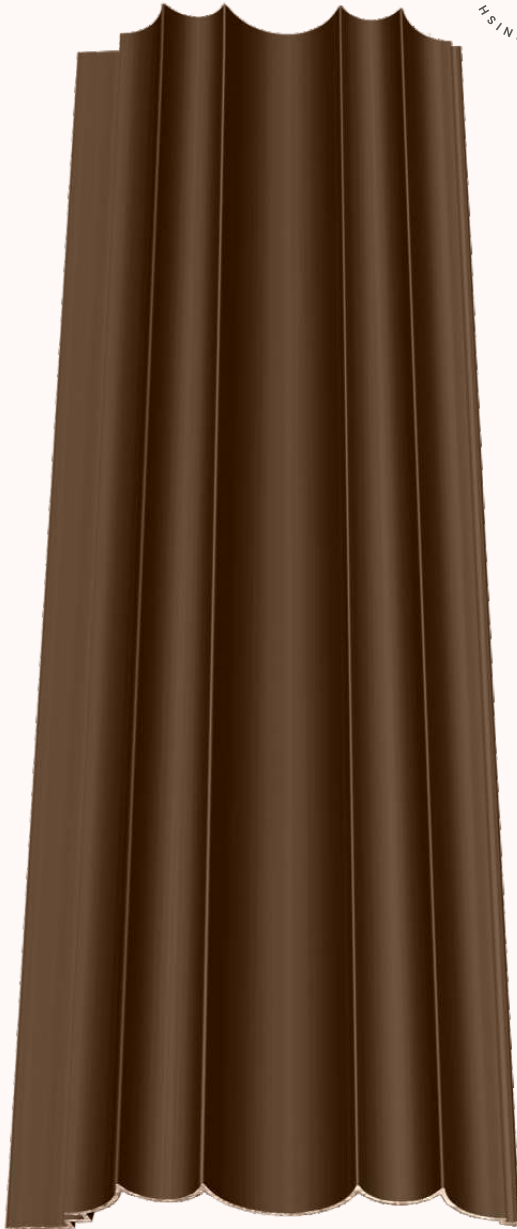

90° Inner Profile

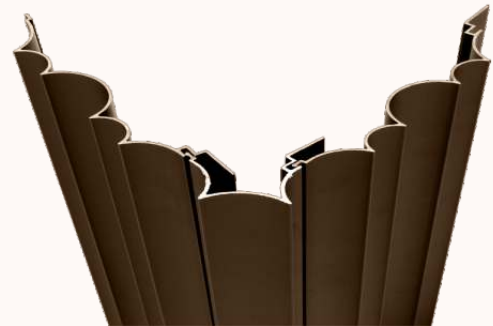

90° Outer Profile



End Profile

GL 12 2900mm x 121mm x 25mm

Material	Length	Coverage	Weight	Thickness	Tolerance
AL 6063-T5	2900mm	3.15 Sq.ft	1.45 Kg.	1.1mm	±0.20mm

Panel Profile

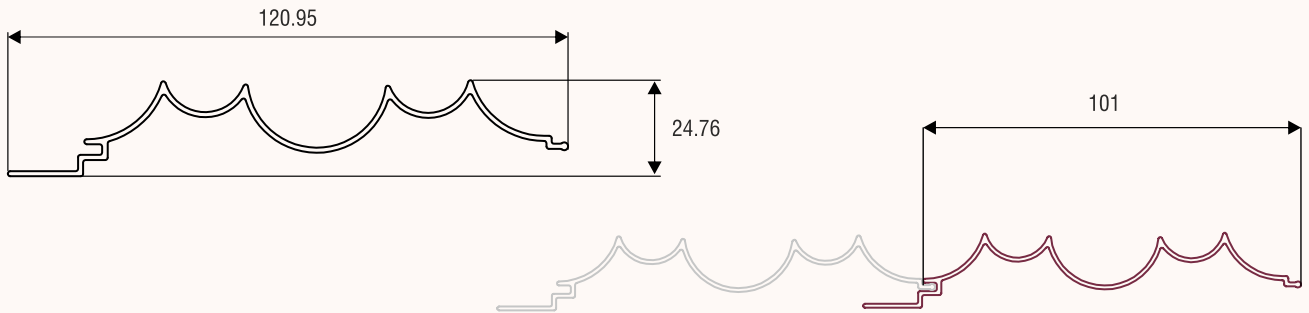

Adjoining Panel Placement

End Profile

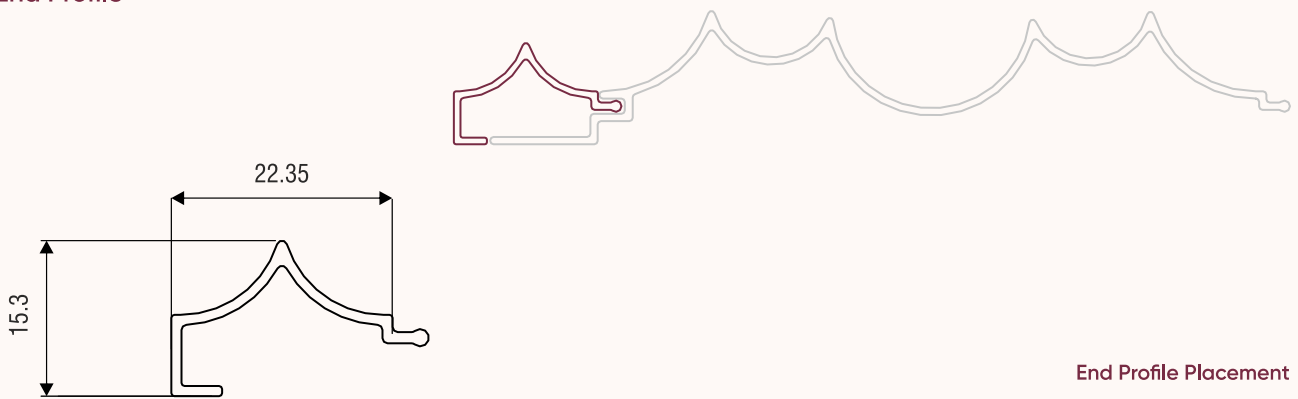

End Profile Placement

90° Inner Profile

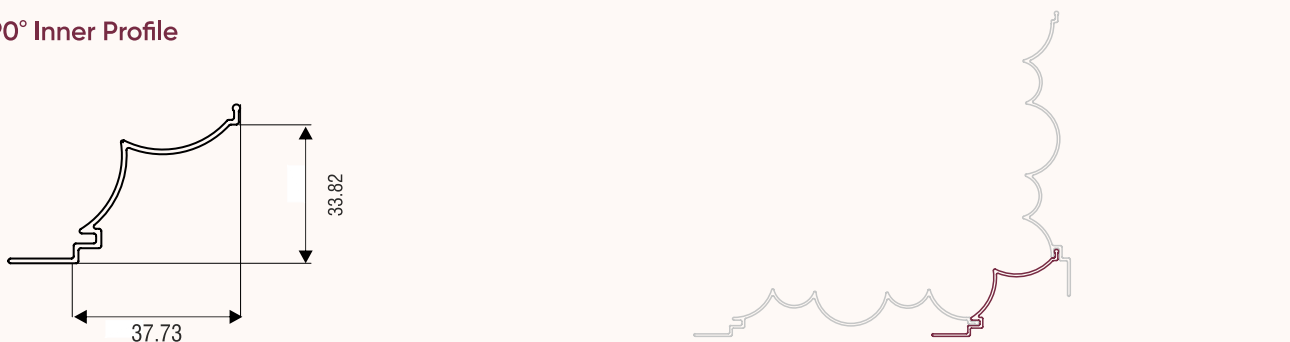

Inner Profile Placement

90° Outer Profile



Outer Profile Placement

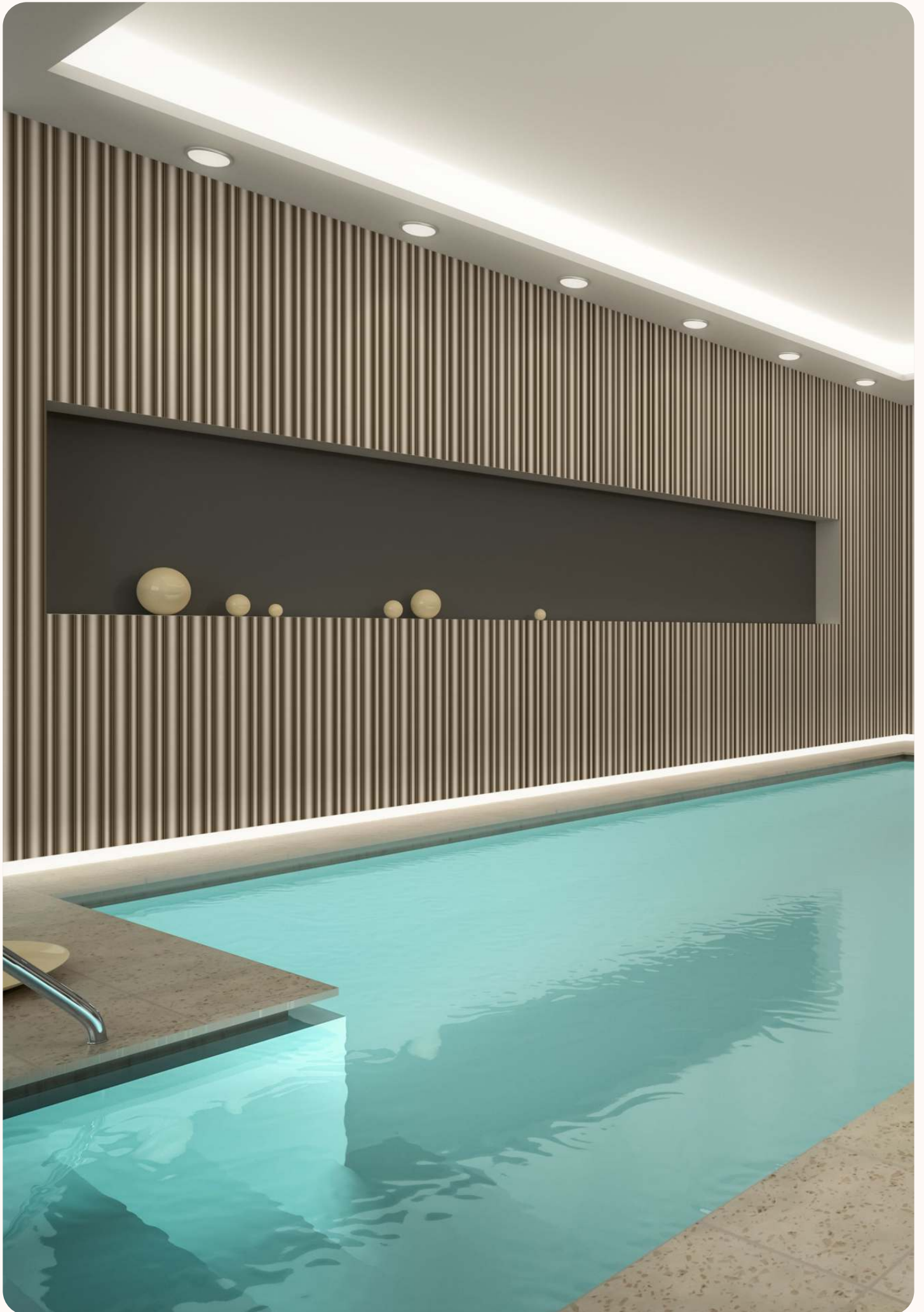



GL 13 2900mm x 121mm x 25mm

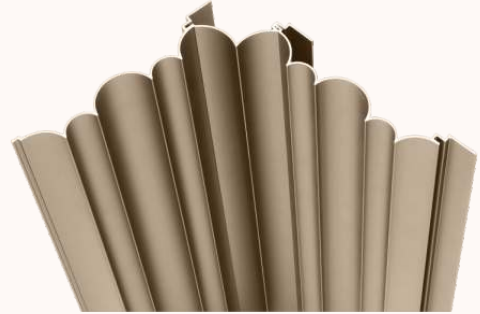

90° Inner Profile



90° Outer Profile



End Profile

Material	Length	Coverage	Weight	Thickness	Tolerance
AL 6063-T5	2900mm	3.15 Sq.ft	1.45 Kg.	1.1mm	±0.20mm

Panel Profile

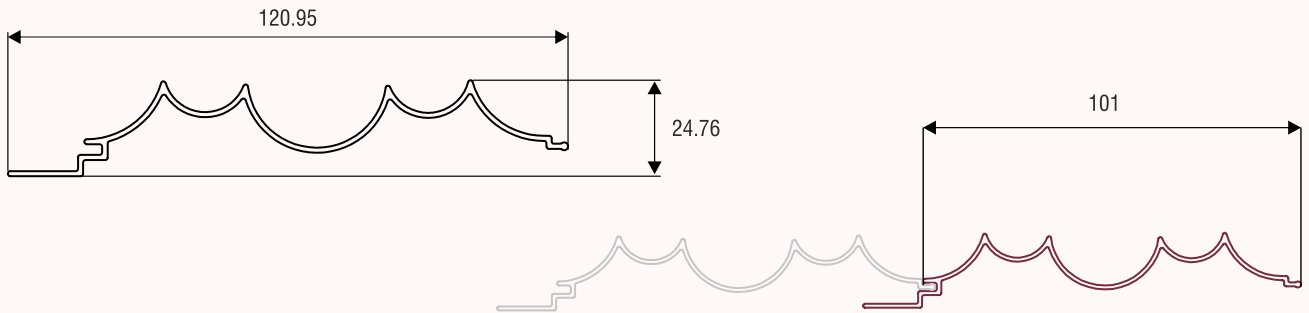

Adjoining Panel Placement

End Profile

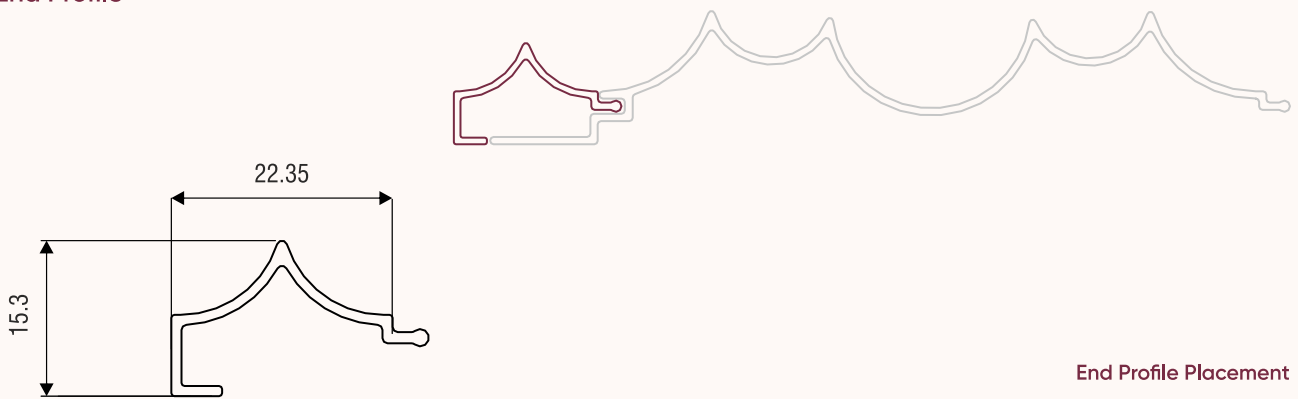

End Profile Placement

90° Inner Profile

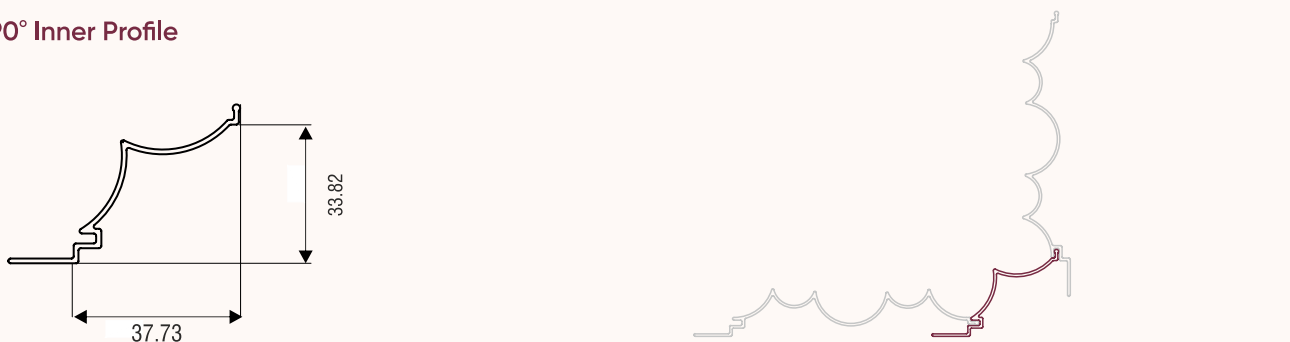

Inner Profile Placement

90° Outer Profile

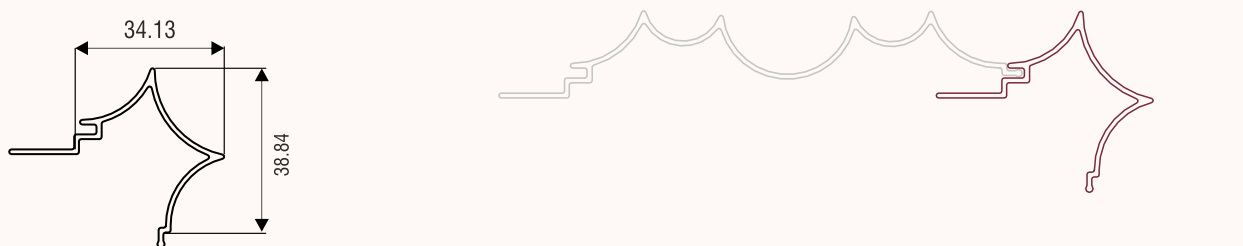

Outer Profile Placement



GL 14 2900mm x 121mm x 25mm

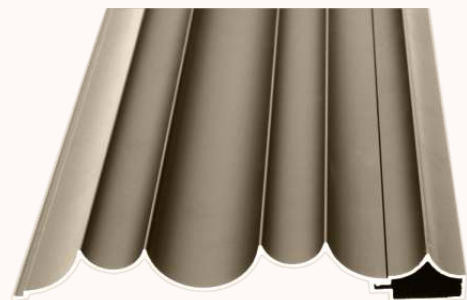

End Profile

Material	Length	Coverage	Weight	Thickness	Tolerance
AL 6063-T5	2900mm	3.15 Sq.ft	1.45 Kg.	1.1mm	±0.20mm

Panel Profile

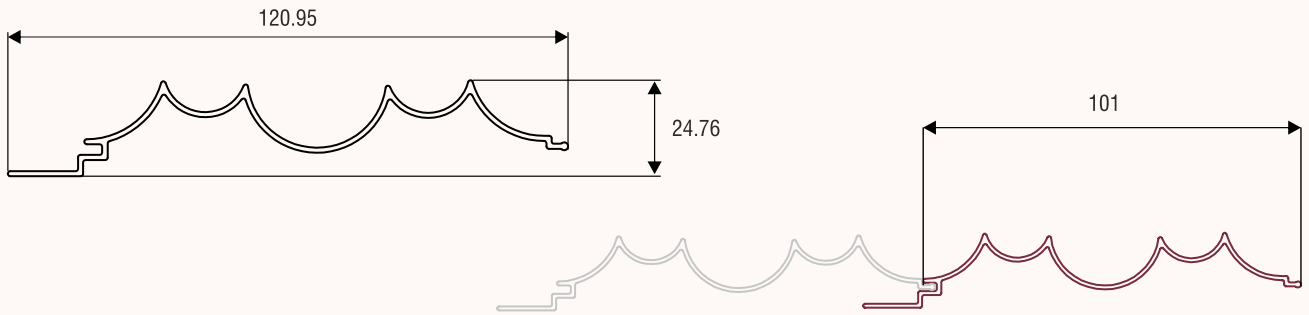

Adjoining Panel Placement

End Profile

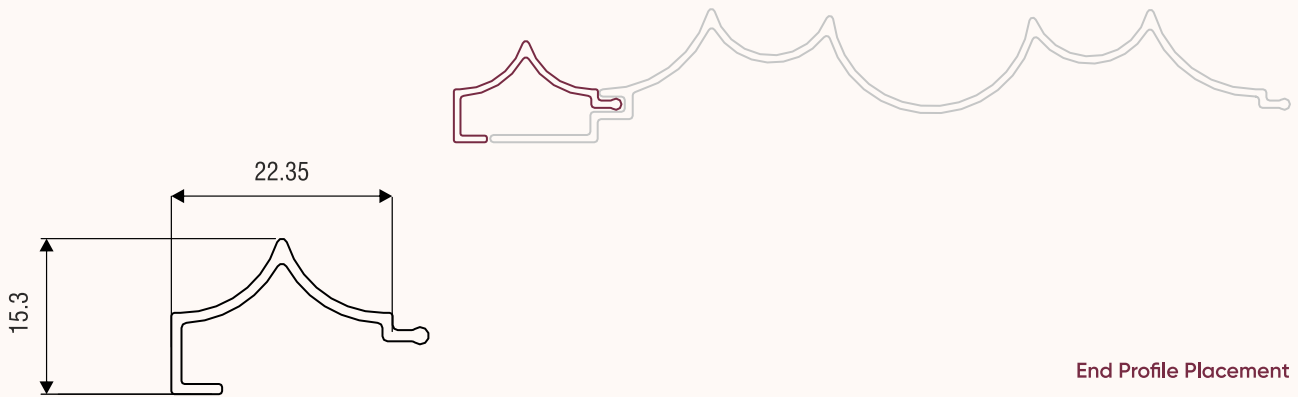

End Profile Placement

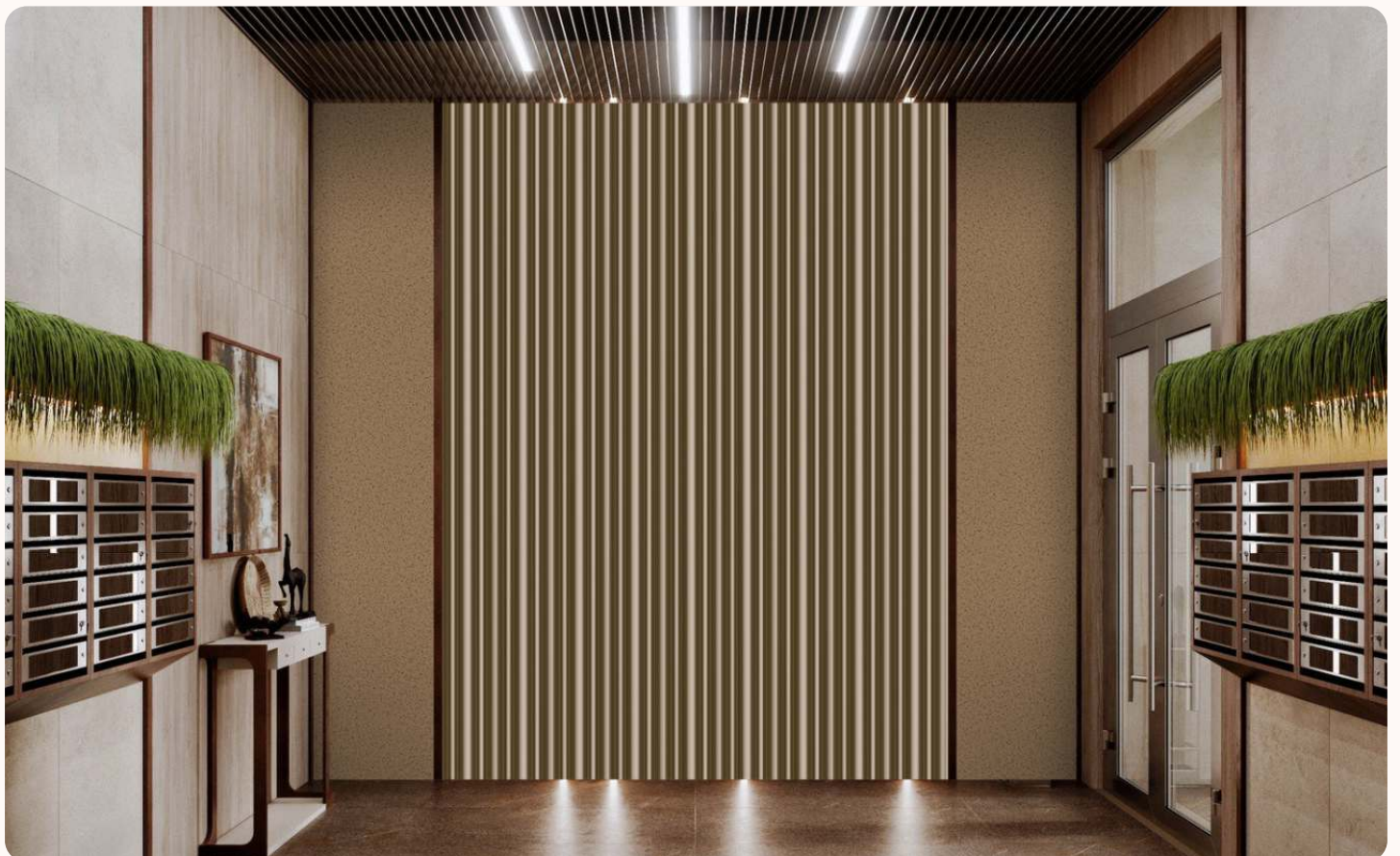

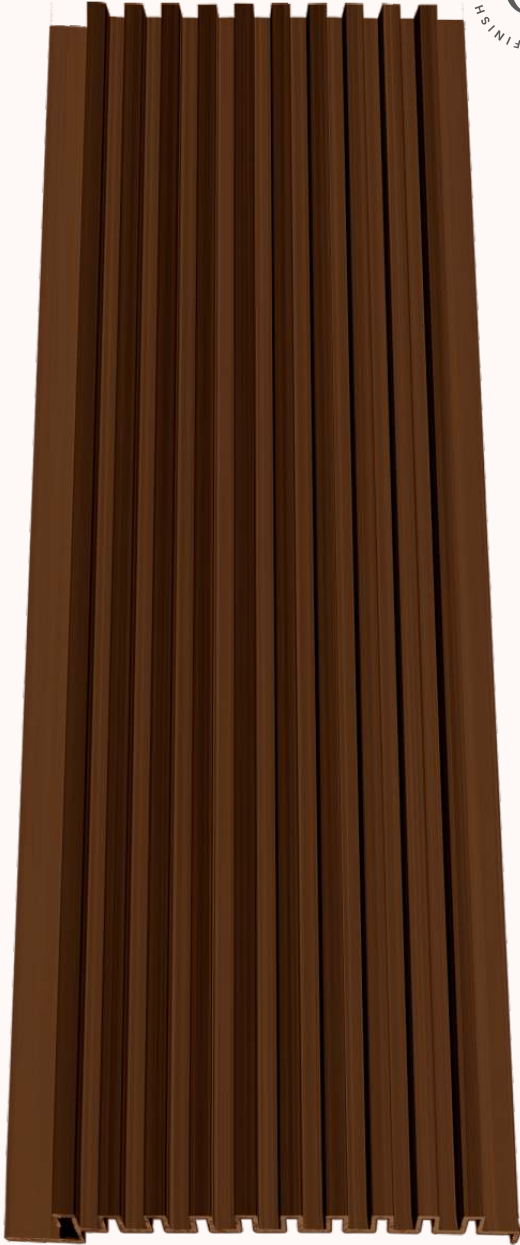

GL 21 2900mm x 116mm x 10mm



End Profile

Material	Length	Coverage	Weight	Thickness	Tolerance
AL 6063-T5	2900mm	3.12 Sq.ft	1.78 Kg.	1.0mm	±0.20mm

Panel Profile

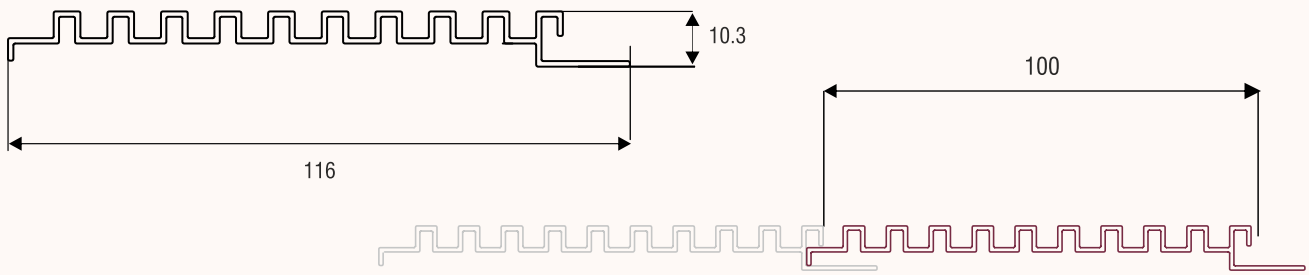

Adjoining Panel Placement

End Profile

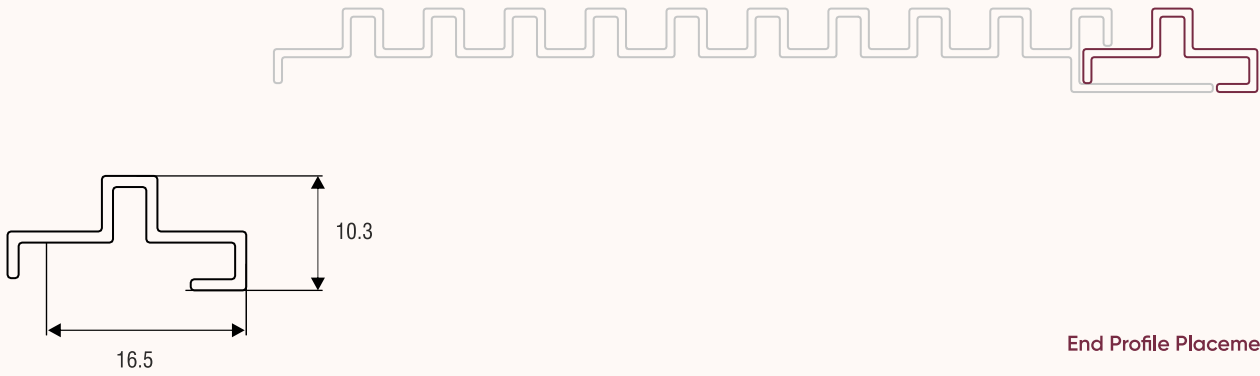

End Profile Placement





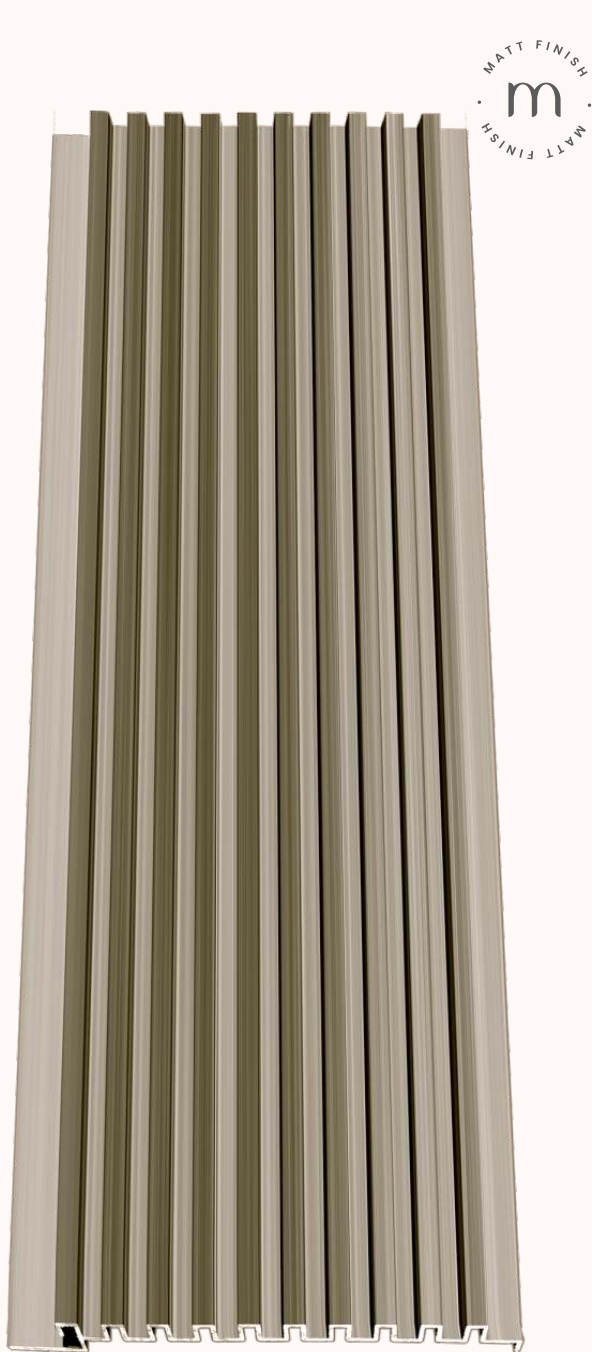

GL 22 2900mm x 116mm x 10mm

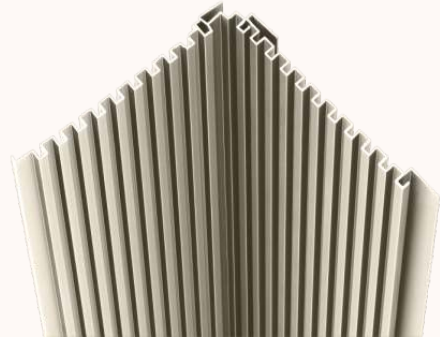

90° Inner Profile

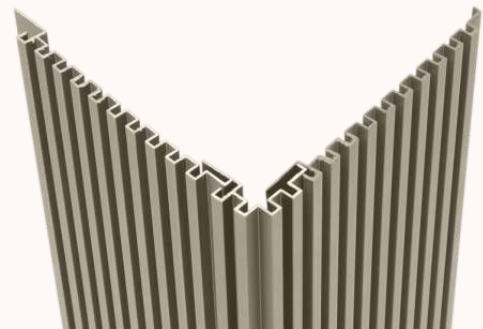

90° Outer Profile

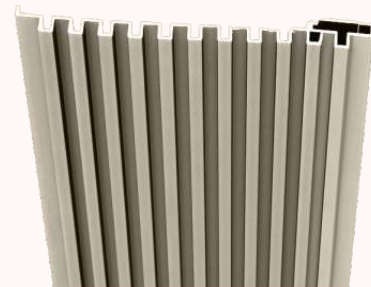

End Profile

Material	Length	Coverage	Weight	Thickness	Tolerance
AL 6063-T5	2900mm	3.12 Sq.ft	1.78 Kg.	1.0mm	±0.20mm

Panel Profile

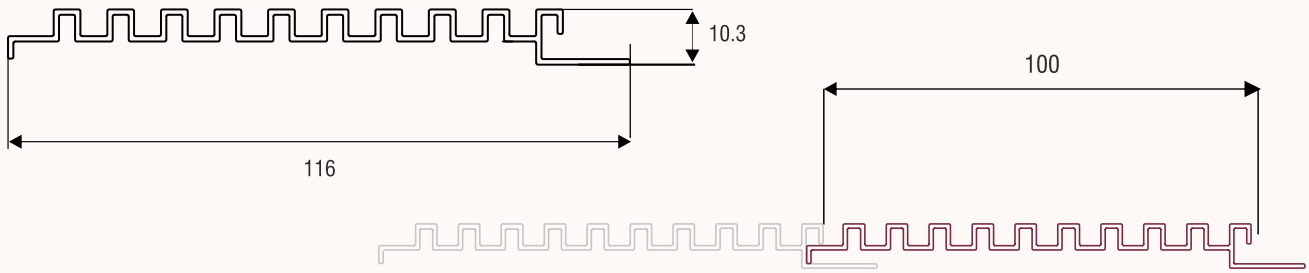

Adjoining Panel Placement

End Profile

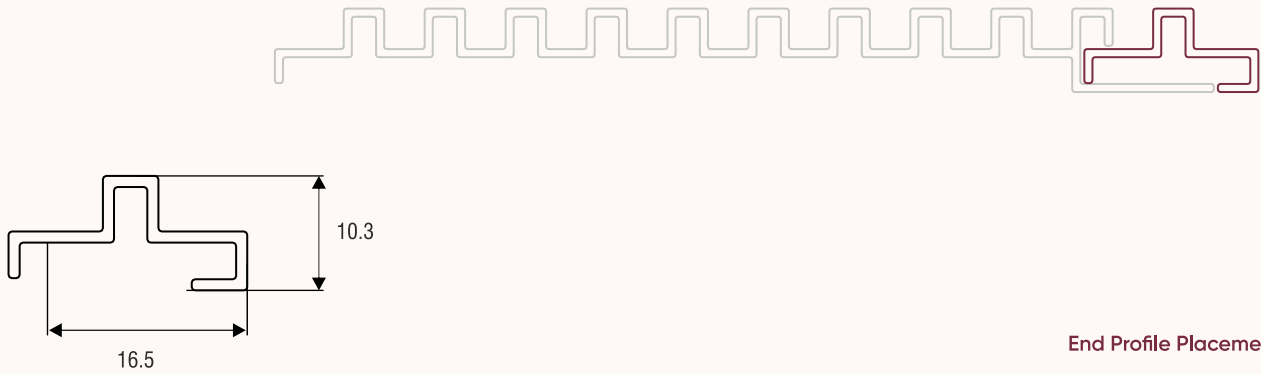

End Profile Placement

90° Inner Profile



Inner Profile Placement

90° Outer Profile



Outer Profile Placement

G
GLOOSY FINISH · GLOOSY FINISH · GLOOSY FINISH



GL 31 2900mm x 238mm x 26mm

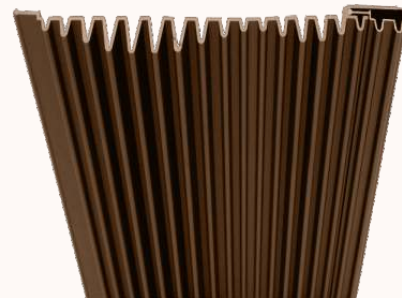

End Profile

Material	Length	Coverage	Weight	Thickness	Tolerance
AL 6063-T5	2900mm	6.84 Sq.ft	7.54 Kg.	1.7mm	±0.20mm

Panel Profile

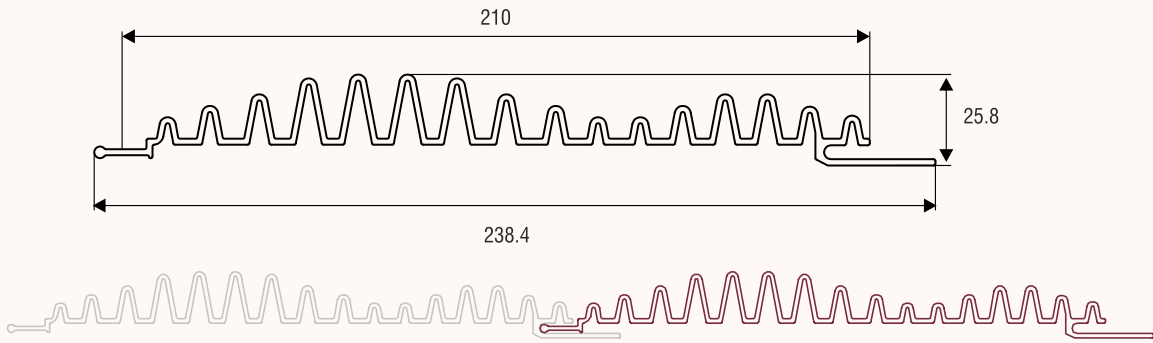

Adjoining Panel Placement

End Profile

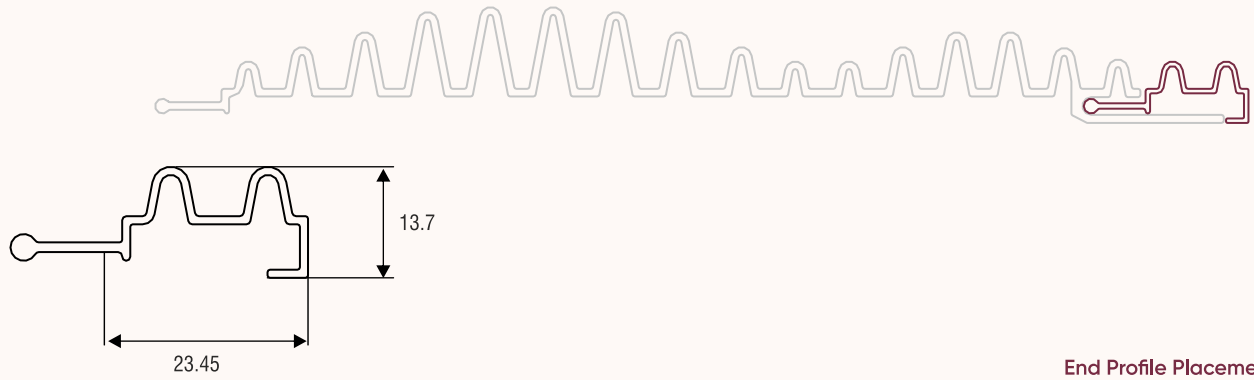

End Profile Placement





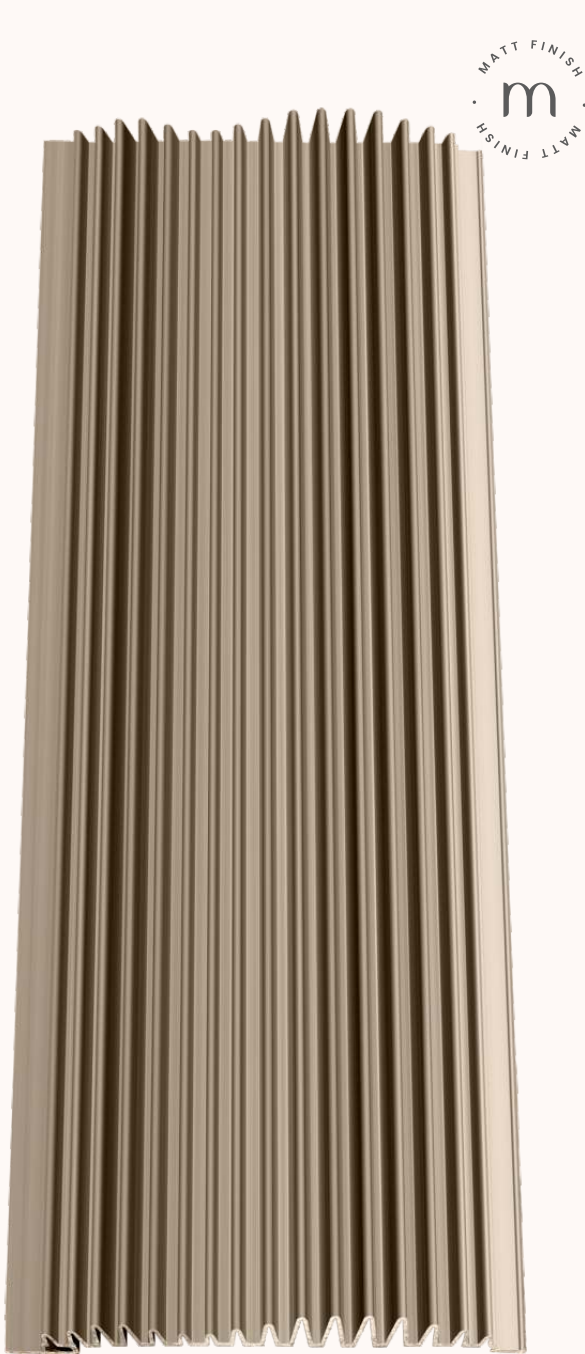

GL 32 2900mm x 238mm x 26mm

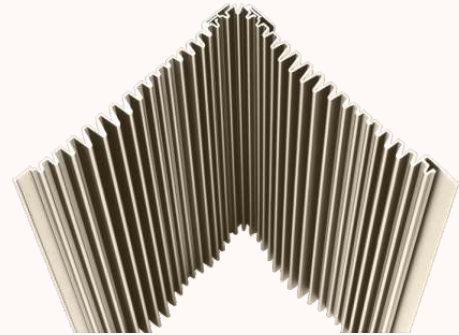

90° Inner Profile



90° Outer Profile

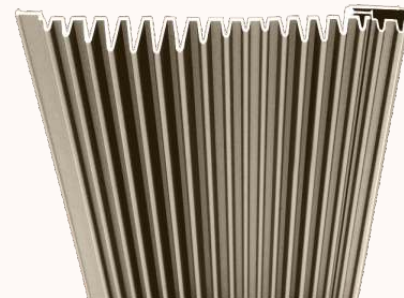

End Profile

Material	Length	Coverage	Weight	Thickness	Tolerance
AL 6063-T5	2900mm	6.84 Sq.ft	7.54 Kg.	1.7mm	±0.20mm

Panel Profile

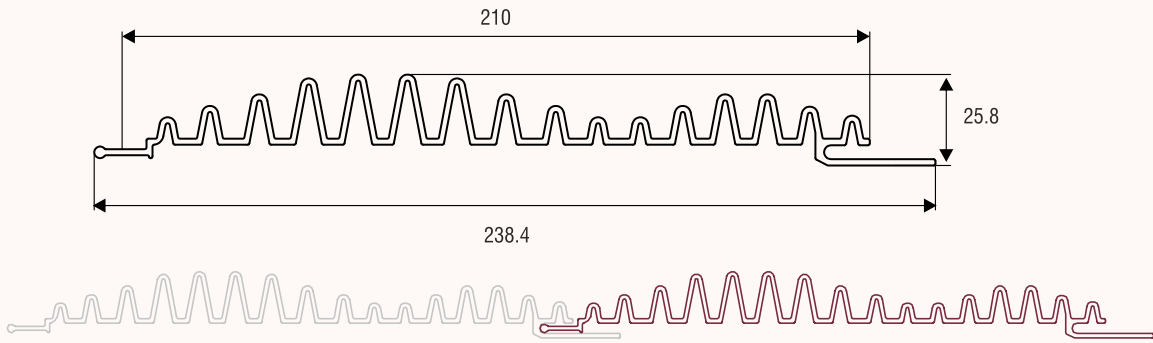

Adjoining Panel Placement

End Profile

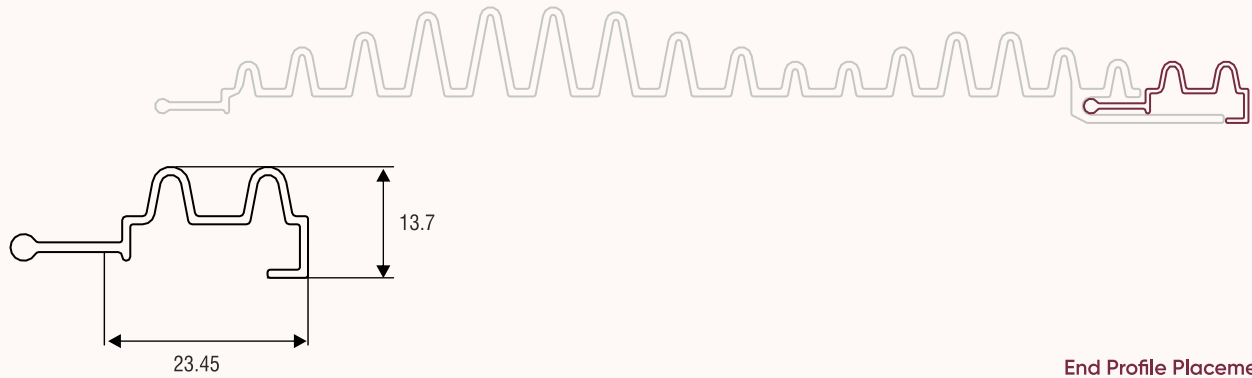

End Profile Placement

90° Inner Profile



Inner Profile Placement

90° Outer Profile

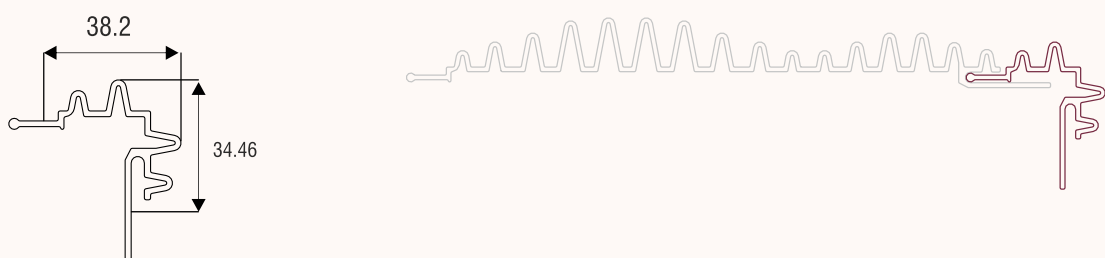

Outer Profile Placement

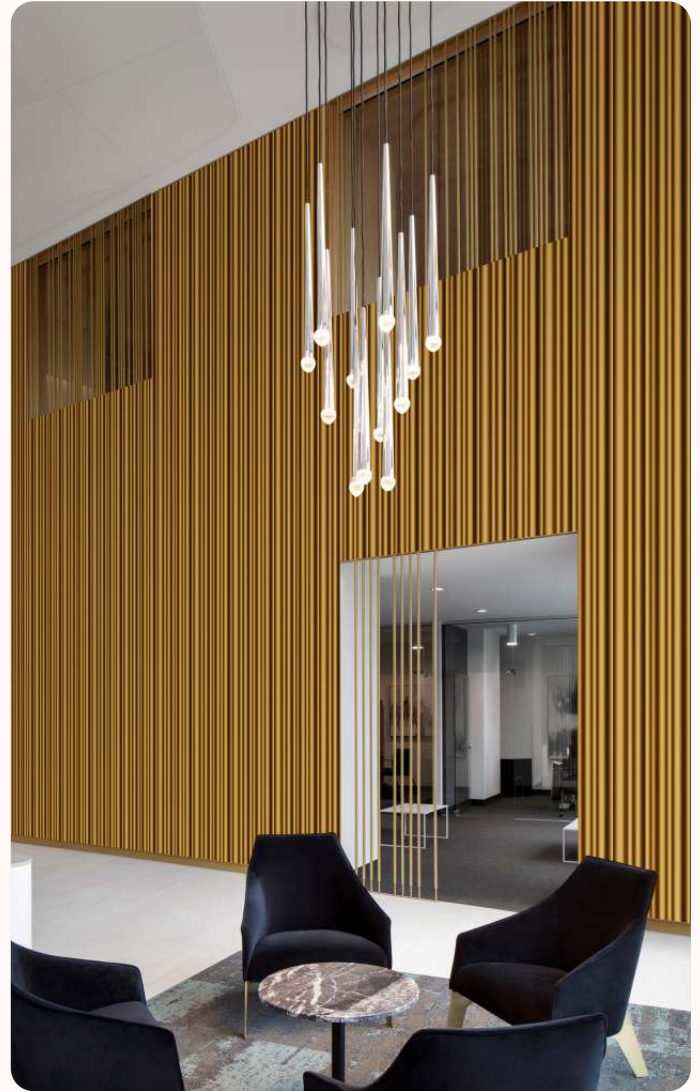

GL 41 2900mm x 156mm x 46mm



End Profile

Material	Length	Coverage	Weight	Thickness	Tolerance
AL 6063-T5	2900mm	4.25 Sq.ft	3.65 Kg.	1.5mm	±0.20mm

Panel Profile

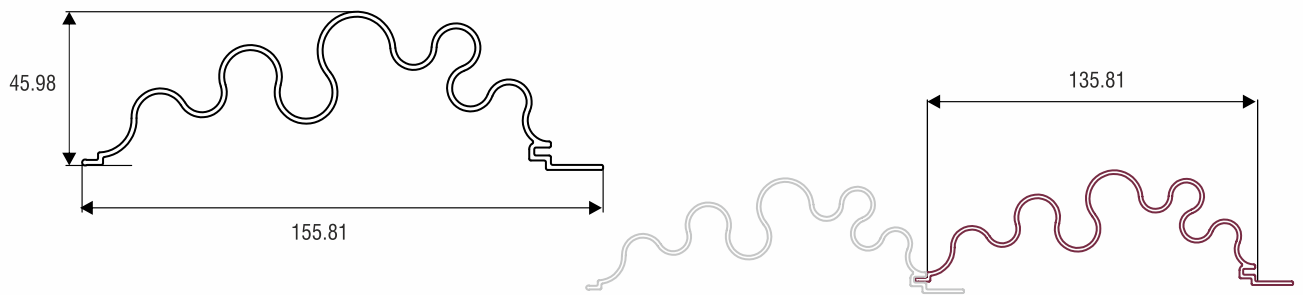

Adjoining Panel Placement

End Profile

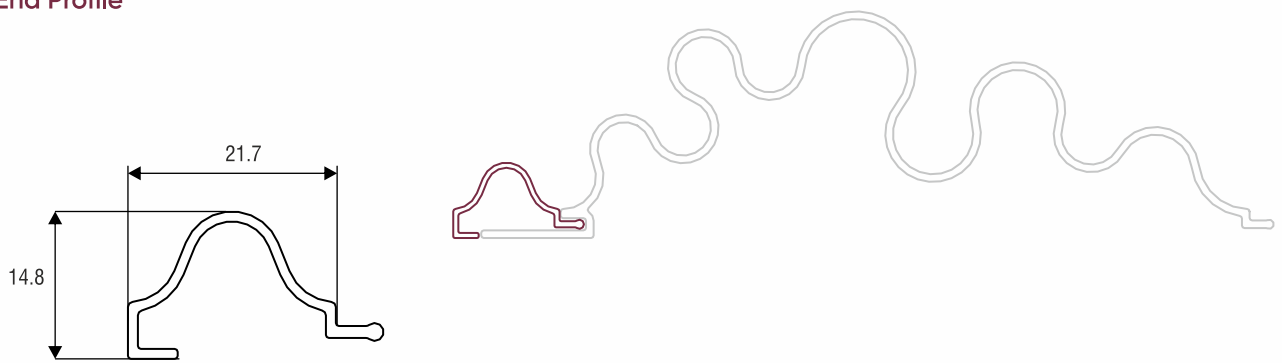

End Profile Placement

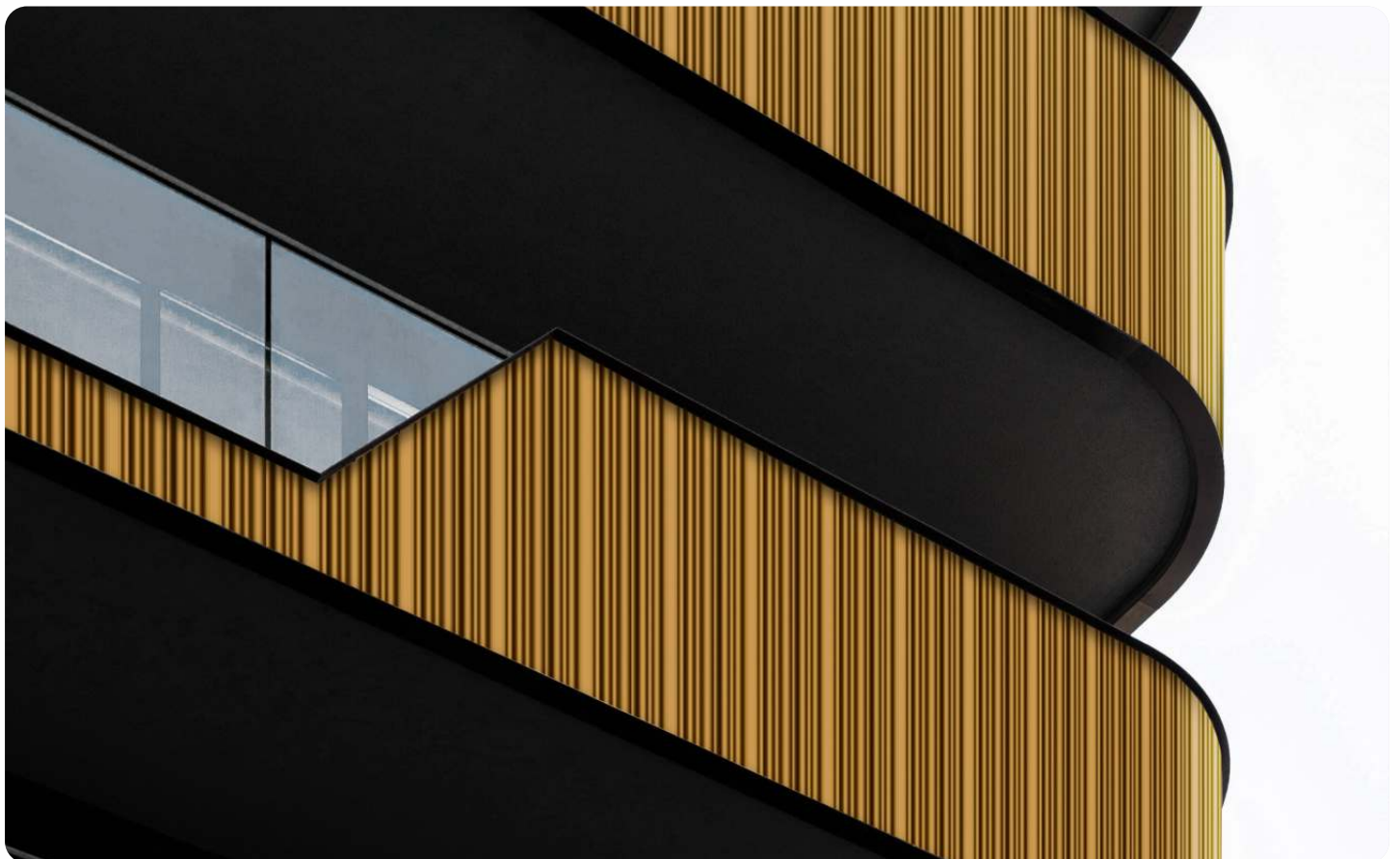

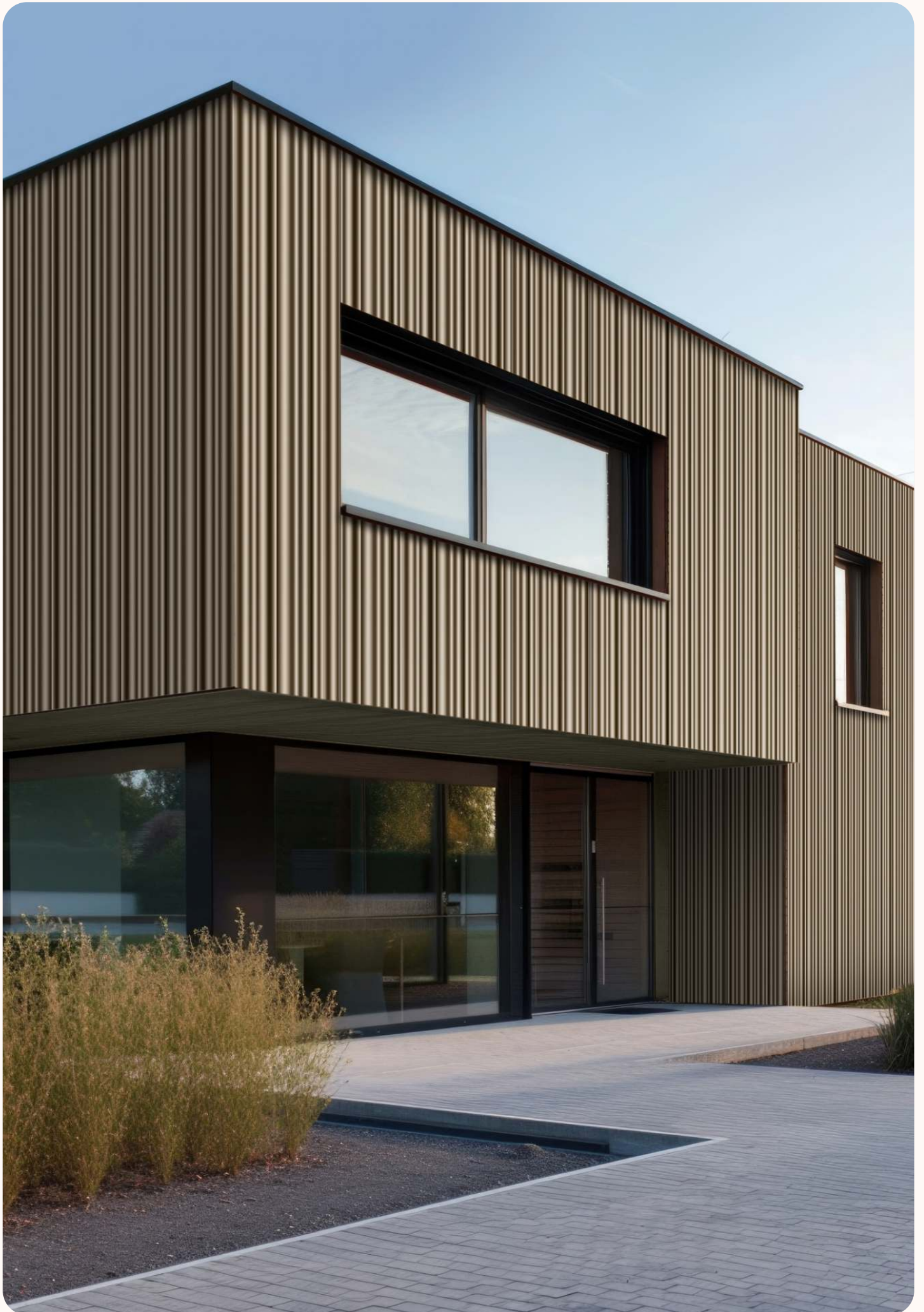

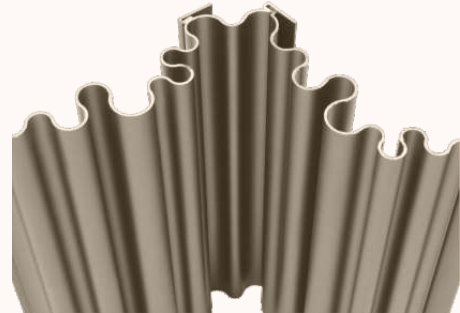

90° Inner Profile

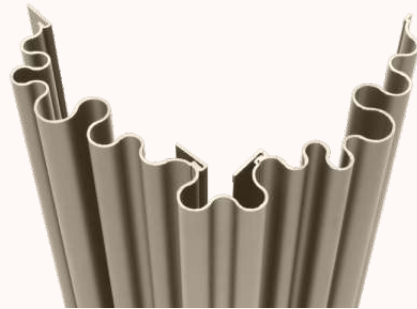

90° Outer Profile



End Profile

GL 42 2900mm x 156mm x 46mm

Material	Length	Coverage	Weight	Thickness	Tolerance
AL 6063-T5	2900mm	4.25 Sq.ft	3.65 Kg.	1.5mm	±0.20mm

Panel Profile

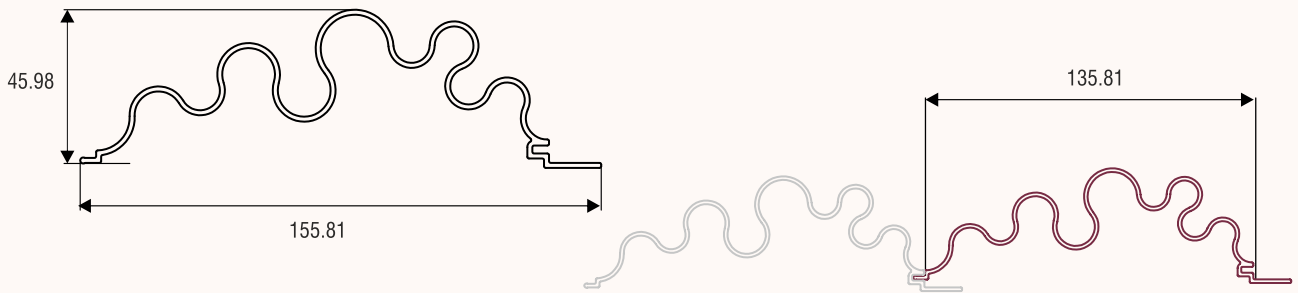

Adjoining Panel Placement

End Profile

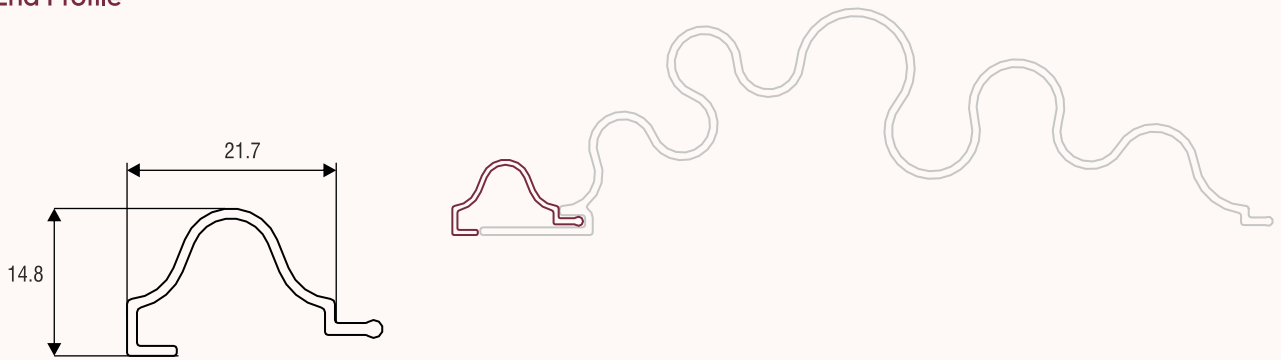

End Profile Placement

90° Inner Profile

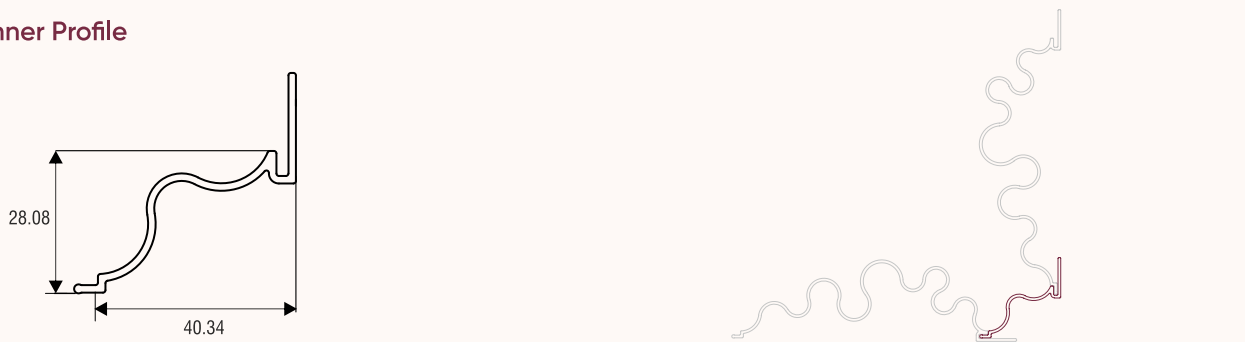

Inner Profile Placement

90° Outer Profile

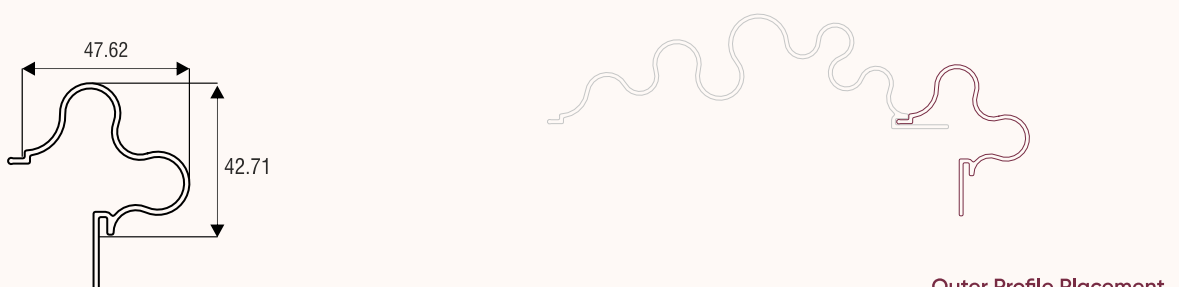

Outer Profile Placement



GL 51 2900mm x 174mm x 44mm



End Profile

Material	Length	Coverage	Weight	Thickness	Tolerance
AL 6063-T5	2900mm	5.37 Sq.ft	3.70 Kg.	1.5mm	±0.20mm

Panel Profile

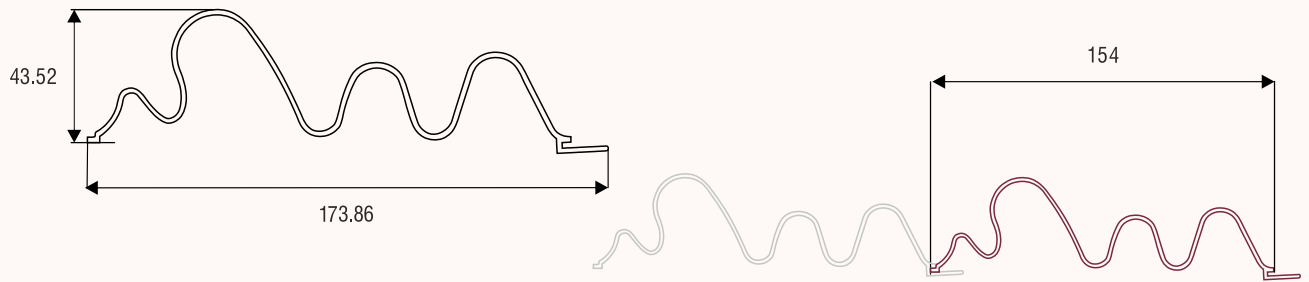

Adjoining Panel Placement

End Profile



End Profile Placement





GL 52 2900mm x 174mm x 44mm



End Profile

Material	Length	Coverage	Weight	Thickness	Tolerance
AL 6063-T5	2900mm	5.37 Sq.ft	3.70 Kg.	1.5mm	±0.20mm

Panel Profile

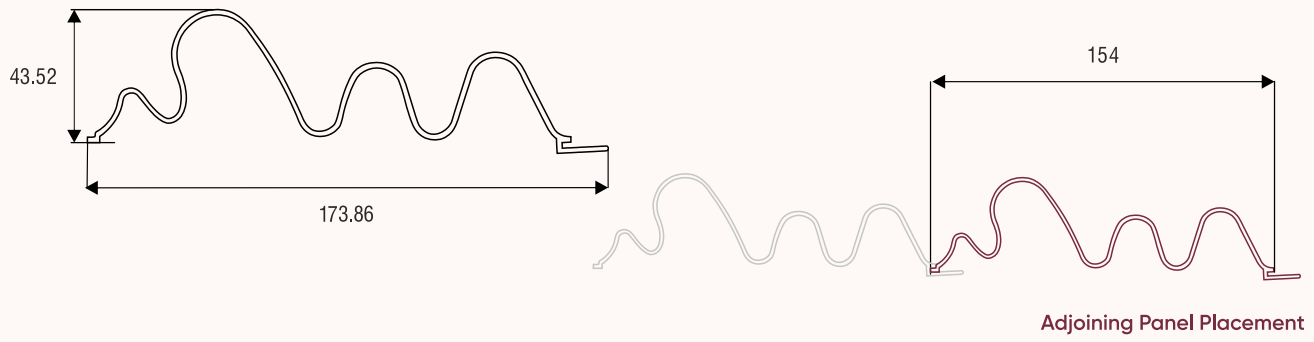

End Profile



ALULUXE

Unveiling Metal's True Beauty

PRODUCTS RANGE

STENCIL
PAINTABLE PANEL

IRIS
CRAFTSMEN IDEOLOGY
MADE SEAMLESS

FLUTE ST
RY
ACRYLIC FLUTED PANEL

Pluto
METALLIC PANELS

SIROCCO
PURE ESSENCE TO YOUR DECOR

EMPORIO
INDEED A QUALITY PRODUCT

CALYPSO
PANELS

MIRRACO
Smart Panels
SMART MIRROR PANELS

JADE
COLLECTION

FUSION
PANELS

CRYSTA
1.5 Anti Scratch Acrylic

The **grace**
of decor
METAL AND FABRIC
PANELS

STYRO
CHARCOAL
PANELS
ARTISTIC WALL PANELS
FROM KOREA

Clariss
Mirror Engraved Panels

Genesis
1 MM ANTISCRATCH
ACRYLIC LAMINATES

CHROME
2 mm acrylic laminates

WALLSTAR
European Design
MOULDING FROM KOREA

PU CORE
1.5 MM PVC
CORE LAMINATES

**EDGE
BAND**
GLASS LOOK 1.3 MM
EDGE BENDING TAPES

ALABASTER
TRANSLUCENT SHEETS

CANEX
ERA OF TRADITIONAL ART

LAMITEQ
Ultra Luxury Laminates

STYRO
edge

ignis
PREMIUM FINISH
FIRE RETARDANT LOUVERS

**Thermo
Luxe**
Where Luxury
Meets Style
by
GLOIRIO
style your interior



GLOIRIO[®]
style your interior



Scan this for Website

🌐 | www.gloirio.com | [f](https://www.facebook.com/gloirio) | [@](https://www.instagram.com/gloirio) | gloirio

THERE CAN BE VARIATIONS IN MATERIAL FROM DIFFERENT BATCHES.
IT IS ADVISED TO USE SAME BATCH MATERIAL TO AVOID COLOUR VARIATION.

For more details subscribe to our [YouTube](#) channel 'GLOIRIO VOUGUE DECOR'
for information about products, its installation and new exciting offers

WATCH OUT FOR GLOIRIO MARK ON EACH SAMPLE TO AVOID DUPLICATION